

PRODUCT MANUAL

8-Zone RGB Remote Control

Product Description

Our 8 Zone color changing RGB-W remote control is fully wireless and can control up to 8 different light zones using just one remote control. The SenseControl color wheel allows easy color selection, and can be fine tuned to an exact color using the single color buttons. The controller works great with any LED products which use four channels, such as RGBW (red, green, blue and white). A wall holder is also included for secure and easy storage.

Main Functions:

- Control up to 8 Receivers (1 Included) individually or as a group
- Brightness levels can be controlled for each individual color/zone
- Built in Color Changing Programs with chase effects
- Memory Function remembers last setting if power goes out
- On/Of switch of individual zones or all lights
- Full Brightness Control
- 50 Foot Wireless Control

This manual reviews:

- Entire installation process
- Product features and primary uses
- Detailed functionality
- Troubleshooting options
- Technical Parameters



Remote Control



Receiver

PRODUCT MANUAL

8-Zone RGB Remote Control



Sign, Screen & Digital Printing Supplies
800-282-5440 martin-supply.com
2740 Loch Raven Rd., Baltimore, Maryland 21218
sales@martin-supply.com

8-Zone RGB Remote Control

The 8 Zone RGB Remote Control and matching receivers can control up to 8 four channel RGB-W zones as a group or independently for zones running from 12V to 36V DC. After the installation is complete, you can change the colors, play pre-programmed color changing programs, or change brightness levels on each LED zone independently from 0% to 100% brightness.

Tools Required:

- 3 AAA Batteries for Remote Control
- Philips Screwdriver
- Flat Head Screwdriver
- Wire Stripper

Setting up the dimming system:

This section will show you how to complete the wiring for one zone with a single receiver. To wire another zone, repeat the following steps with another receiver.



- 1 Remove the white plastic end caps on both ends of the receiver using the Philips screwdriver. This will expose the green wiring slot blocks.



- 2 To add power to the receiver, first make sure the power supply uses the correct voltage (12-24V DC). Then make sure the power supply is not plugged in. Take the negative wire coming from the power supply, and using the Wire Stripper, strip of approximately 1/4" of cover from the end of the wire. Twist the exposed metal wire to help make a secure connection.

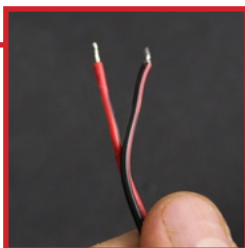

...continued on next page

PRODUCT MANUAL

8-Zone RGB Remote Control

- 3 On the left green wiring slot block for the power supply, use the Philips Screwdriver to rotate the negative wiring screw counter clockwise to open the wiring slot located below the screw. The screw will not come out.

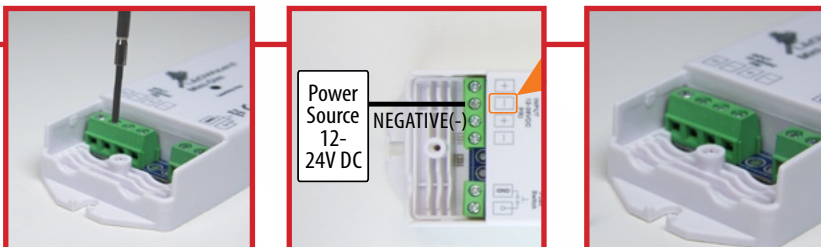

- 4 Take the negative wire and insert the exposed metal end into the negative wiring slot located below the screw. Place the wire inside until the wire stops against the wall inside the negative wiring slot. Take the Philips Screwdriver and turn the negative wiring screw clockwise until the screw is snug. The negative wire has now been secured to the receiver and should not come out. If it does come out, repeat from step two, and place the exposed metal wire further into the negative wiring slot.



- 5 Repeat steps two through four for the positive wire from the power supply. The positive wire will go into the positive wiring slot.

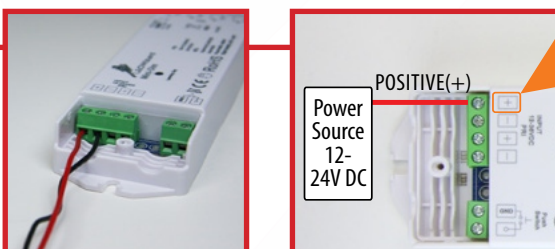

- 6 On the right side of the receiver, connect the LED fixture, being careful to match the correct color wires with the matching ports. The positive wire is usually connected using the red (+) positive terminal on the top right of the receiver as shown on the wiring diagram for the receiver on page 4.

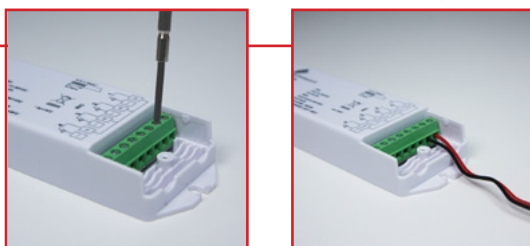

PRODUCT MANUAL

8-Zone RGB Remote Control

8-Zone RGB Remote Control

- 7 The wiring for the receiver is now complete. Place the white receiver end caps back on the receiver and screw them down securely using the Philips Screwdriver.



- 8 Plug in the power supply to the wall outlet. The LED fixture will turn on automatically. The unit is now ready to pair with the 8 Zone Controller.

Receiver Wiring Diagram:



Adding Batteries to 8 Zone Controller

This section will show you how to install the batteries in your new 8 Zone Controller.

- 1 On the backside of the controller, open the battery cover door by pushing down on the upper door tab. The door will open from the top. Take three AAA batteries and install them in the correct orientation as noted inside the battery area. Reinstall the battery door by inserting the bottom tabs first then carefully pushing the top down until it snaps into place.



...continued on next page

PRODUCT MANUAL

8-Zone RGB Remote Control

Pairing the 8 Zone Controller with receiver

This section will show you how to pair your new 8 Zone Controller with the receiver for one zone.

8-Zone RGB Remote Control

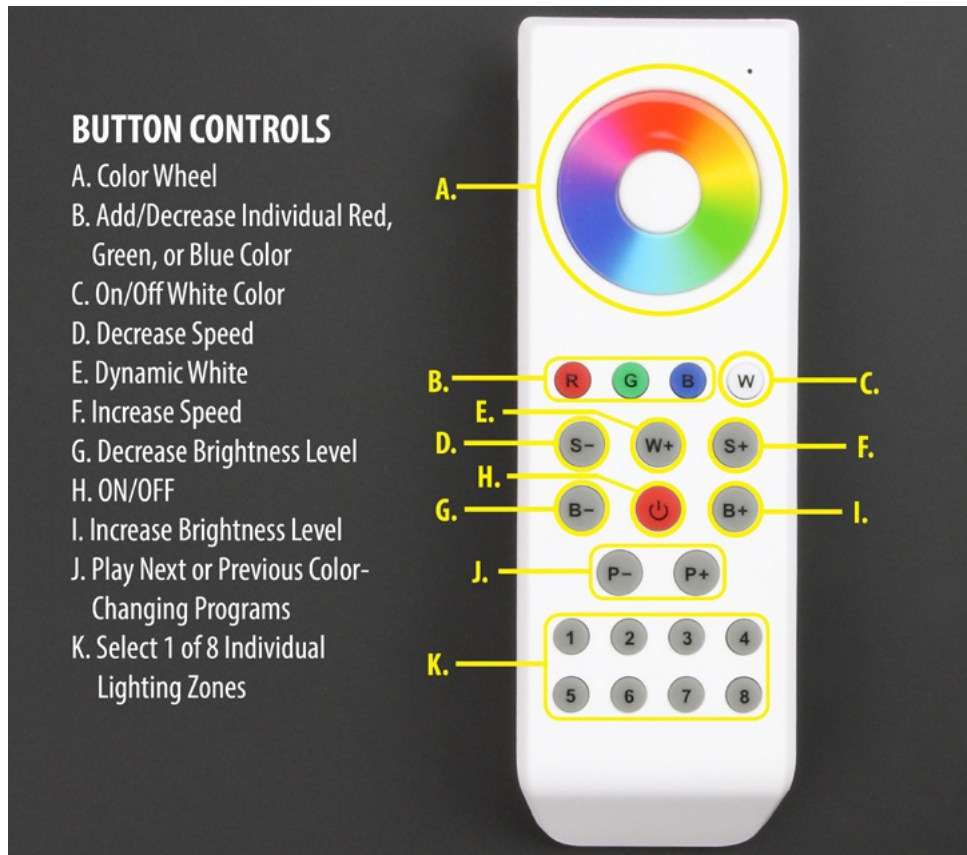

HOW TO PAIR SEVERAL RECEIVERS TO THE REMOTE CONTROL:

The LED Wizard remote control has 8 zone control buttons. Each zone button can control 1 or more receivers.

Let's make a configuration example: You have 5 different zones to control in your installation. Therefore you will have 1 remote control and 5 receivers for each zone. You will need to program each receiver to what number zone they belong. Once the receivers have been correctly wired and powered we will start to define and pair each receiver with its own zone.

Step 1:

- A. Press the red power button in the remote control
- B. Now press any button from 1 to 8 depending in which zone you want to assign to the receiver, in this case we will press button "1" on the remote
- C. Quickly Tap the learning button on the white receiver
- D. Immediately start sliding your finger in the rainbow circle of the remote control, if correctly done, you will see the red LED light blink on the receivers. It will blink for about 3 seconds. Once it stops blinking the receiver has been correctly paired.
- E. Repeat this with other receivers. You can pair all receivers to the same channel, in this case 1, or have them in different channels 1-8

If by any circumstance you wish to reprogram any of the receivers, you will need to "reset" the receiver. To do this, simply press the learning button for 5 seconds until the red LED lights shuts off, and re-do steps A-E above.

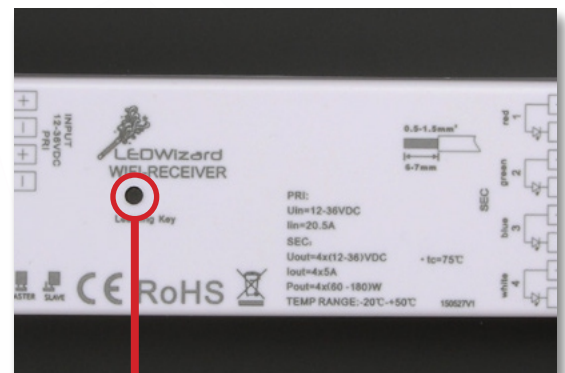

C. Learning Key Button Location

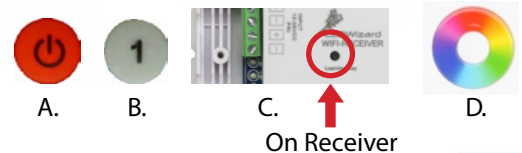

...continued on next page

PRODUCT MANUAL

8-Zone RGB Remote Control

HOW TO TURN OFF A ZONE, AND TURN ON A ZONE:

Any light zone can be turned of completely by pushing and holding a zone button:

1. With the Remote on, Press and Hold one of the 1-8 Zone Buttons until the lights turn of
2. Repeat this process to turn the lights back on, the turned of zone will not turn on using the ON/OFF button.



1.

HOW TO CHANGE COLOR OF LED LIGHTING FIXTURES:

You can change a single receiver color, brightness and saturation individually or in-group.

To change the color of a single receiver follow the following procedure:

1. Press the power button in the remote if the remote is of
2. Select the zone to be controlled pressing any of the 1-8 keys on the remote
3. Move your inger across the touch color wheel, until you see the color that you want



1.

2.

3.

HOW TO CHANGE COLOR OF ALL THE LED LIGHTING FIXTURES SIMULTANEOUSLY:

To change the color of some or all the receivers follow the following procedure:

1. Press the power button in the remote if the remote is of.
2. Press in a rapid succession buttons from 1-8. For example, if we want to change the color of receiver 1,2,3,4, and 5 we will press in a rapid succession the buttons from 1-5 and then use the color wheel to change color of that group of receivers.

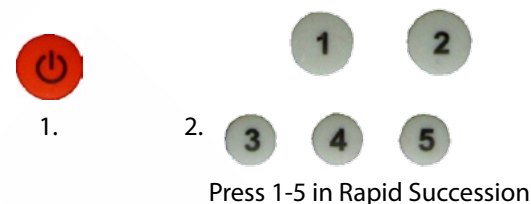

1.

2.

Press 1-5 in Rapid Succession

FAST SELECT OF COLOR AND FINE-TUNING COLORS:

The 4 color buttons (at right) are used to access a primary color quickly, and or to create mixing of colors in a very easy way.

1. If you press the red button, you will see your selected receivers and LED lights turn to red. If you press RED again, you will turn of the RED in all selected receivers. This principle applies for the rest of the buttons (Green, Blue and White)
2. Mixing colors: You can create a mix of color by pressing 2 or more buttons. For example, if we want to create a "purple color" we need to use RED and BLUE for this. Therefore press the red and then the blue color.
3. Every time you press a color button, you either turn on the color or turn it of.

Example: If we press the red button, we will get RED lights. If then we press the Blue Button, we will get, Purple (Red + Blue). If now we press the green button, we will get white lights (Red + Green + Blue). If we now press the blue button we will turn of the blue, but RED and green will still be on, therefore creating yellow (Red + Green)



1, 2, 3

HOW TO FINE TUNE COLORS:

Imagine you want to create a very strong purple color made of the RED and Blue colors. Nevertheless you don't wish to have so much blue in the color mix. You can increase and decrease the brightness of any of the colors individually, in this case we want to decrease the Blue. First make sure that you have selected the zone you want to change using the 1-8 zone buttons on the remote, and that you have pressed the power button on the remote.

1. Tap the red button and you will see te lights in that zone turn red.
2. Now press the blue button for more than 2 seconds until the blue LED turns on.
3. Now place your finger in the rainbow color wheel and start moving your finger clockwise to increase the Blue color until it reaches your taste.

You will see that if you move your finger around the color wheel you will increment the blue and if you move your finger counter clockwise you will reduce the amount of blue in the color mix. . . . If you want to stop controlling the brightness press the "Blue" color button for more than 2 seconds or until the LED light turns off.

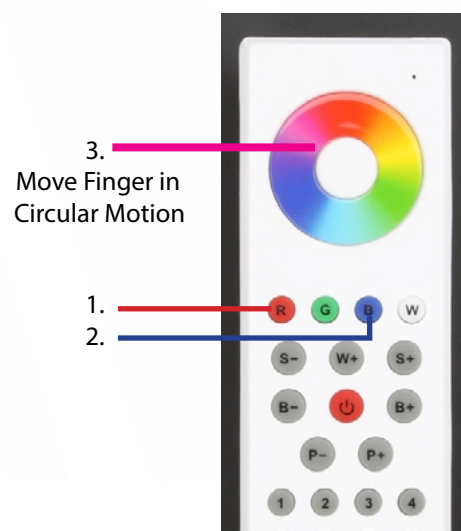

PRODUCT MANUAL

8-Zone RGB Remote Control

COLOR FADING PROGRAMS:

The 8 Zone remote control has 10 predefined color changing programs. You can control the speed and brightness of any program.

Also, the unit uses smart ID technology to create an amazing color effect when more than one receiver is used.

How to use the Color Effects programs.

1. First select the zones you want to control (1-8).
2. Press the "P+" or "P-" button to start a color changing program.
3. If you press the "P+" or "P-" button again you will pause the current color chase program.
4. If you press the "P+" button again, you will advance to the next program. If you press the "P-" button again, you will go back to the last program.

Here's how it works:

Program1 ---Pause---Program2---Pause---Program3---Pause---Program4---Pause---Program5---Pause---Program6---Pause---Program7---Pause---Program8---Pause---Program9---Pause---Program10

Please Note: You can only navigate through 1 to 10 of the programs, when you reach either end (1 or 10) it will not cycle back through the programs if you continue to press "P+" or "P-".

Controlling Speed and Brightness of programs:

Once you selected the program of your choice, you can adjust the speed of the program and brightness levels by using the Brightness and **speed controls**.

1. Use the S- and S+ on the remote to change and fine tune the speed at which the colors change in any of the programs. There are 16 speed levels. The fastest speed is 4 seconds for all the colors to cycle and the slowest speed is 256 seconds.

Changing Brightness:

2. Use the B- and B+ on the remote to change and fine-tune the brightness Levels of the selected program.

Note: The B- and B+ also work when you have individual colors selected.

EXTENDED CONFIGURATION

The 8 Zone controller can work with an unlimited number of receivers. For example, you can have 5 receivers working in zone 1, 10 receivers working in zone 2, and one receivers in zone 3. Also you can have just one receiver on each zone. You can also create a chase effect of colors in just one zone.

Example 1: For example, if you installed 10 receivers controlled by the number "1" zone key on the remote control, the 10 programmed receivers would initially react to button selection at the same time, but as each receiver is a different distance the reaction time is different, and when playing a color changing program, you would notice the lighting tied to each receiver would not be in sync. To prevent this, a "master and slave" programming is needed so that all the receivers will stay in sync with each other.

Example 2: Imagine in zone 1 you want to have 10 receivers. You will have 1 Master and 9 Slaves. The master will transmit a synchronizing signal to all the slaves, so all the receivers work in perfect timing when showing a color changing program is used.

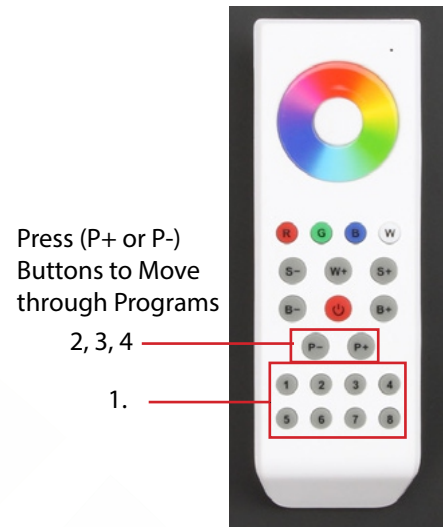

PRODUCT MANUAL

8-Zone RGB Remote Control

HOW TO PROGRAM THE MASTER RECEIVER:

- Press the red power button on the remote.
- On the remote, choose which zone will be used for the master and slave lighting (Tap the number, do not hold)
- On the receiver, tap the learning button.
- On the remote, tap the B+ button to complete the Master receiver pairing. The light red light on the receiver will blink to confirm the pairing is complete.
 (Note: there can only be one Master receiver on each zone.)

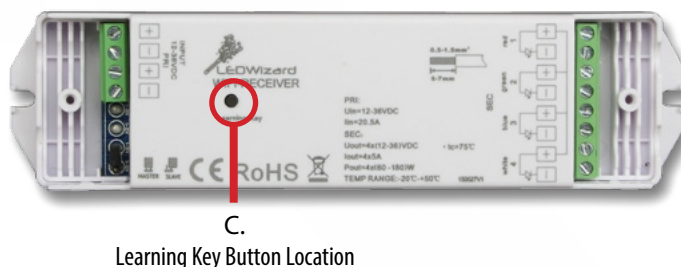
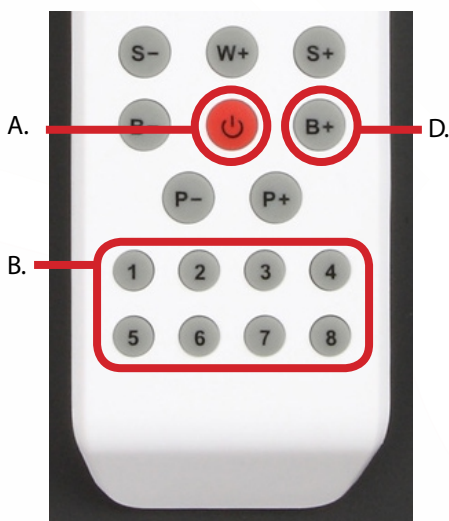

HOW TO PROGRAM THE SLAVE RECEIVER:

- Press the red power button on the remote.
- Choose the same zone the Master receiver was used in (Tap the number, do not hold)
- On the receiver, tap the learning button
- On the remote, slide your finger clockwise on the color wheel until the red light on the receiver blinks, this will confirm the pairing is complete.
 (Repeat this procedure for each slave receiver in the zone)
- The master and slave programming is now complete.

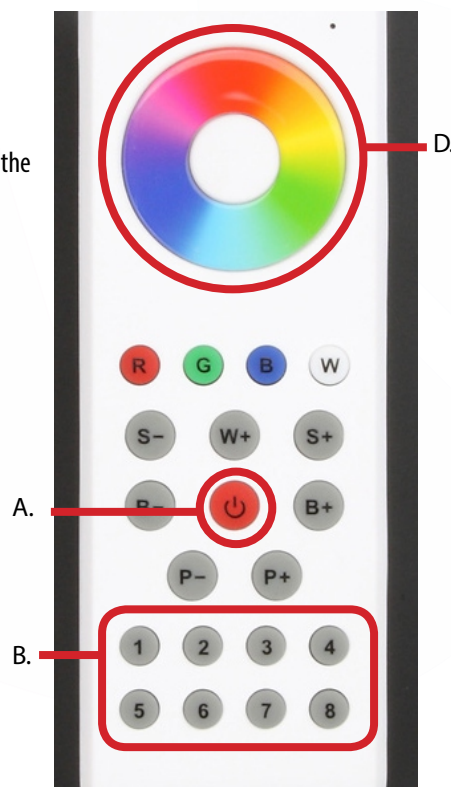

PRODUCT MANUAL

8-Zone RGB Remote Control



Sign, Screen & Digital Printing Supplies
800-282-5440 martin-supply.com
2740 Loch Raven Rd., Baltimore, Maryland 21218
sales@martin-supply.com

Troubleshooting

This section will show you how to troubleshoot the 8 Zone Remote Control and Receiver.

- 1 First check that the batteries are working on the remote, when the remote is turned on, a small red light will appear on the remote on the top right corner. If the light does not come on, replace the batteries as shown on page 4.
- 2 If you are having problems with the lights responding to the 8 Zone in either zone, first check that the remote control is within range of the correct receiver (100 feet maximum).
- 3 Check that the lights in the zone are on, and the wiring to and from the receiver matches the diagram on page 4.
- 4 If there is power going to the receiver and the lights do not shine when turned of and on, the 8 Zone could be dimming the lights in that zone. Select the Zone on the remote, then press and hold the Increase Brightness Button then let go of the button when the lights have reached the desired level of brightness.
- 5 If the lights are still not responding, you can re-pair the receiver to the remote control following the steps A through E on page 5 titled "**HOW TO PAIR SEVERAL RECEIVERS TO THE REMOTE CONTROL**"

Technical Information

Controller

- Wireless 430Mhz Transmission Protocol
- 100 ft wireless range
- Auto OFF for battery longevity
- Requires 3 AAA Batteries (not included)

Receiver

- Voltage Input: 12V DC to 36V DC
- 5A per Channel (60-180W per channel)
- Memory function when power of
- Smart learning function for channel assignment
- Size: 7" x 1-6/8" x 1-6/8"

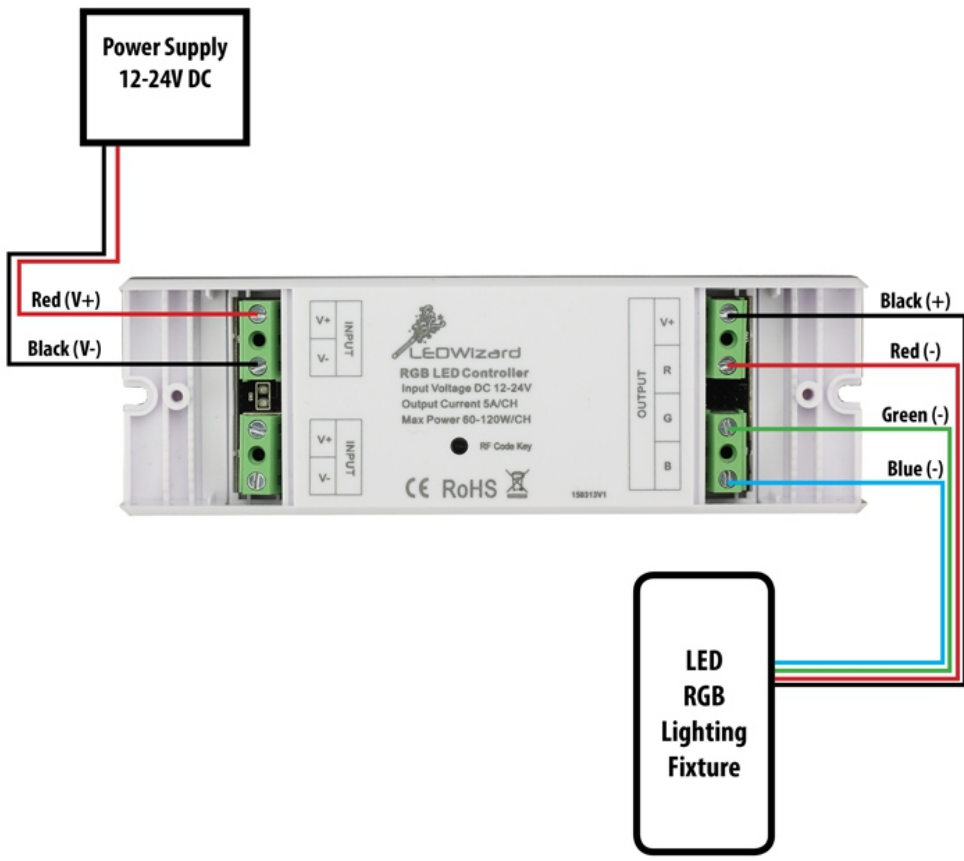

INPUT : 12-36V
Power Supply

**Amplifier/
Repeater
Receiver**

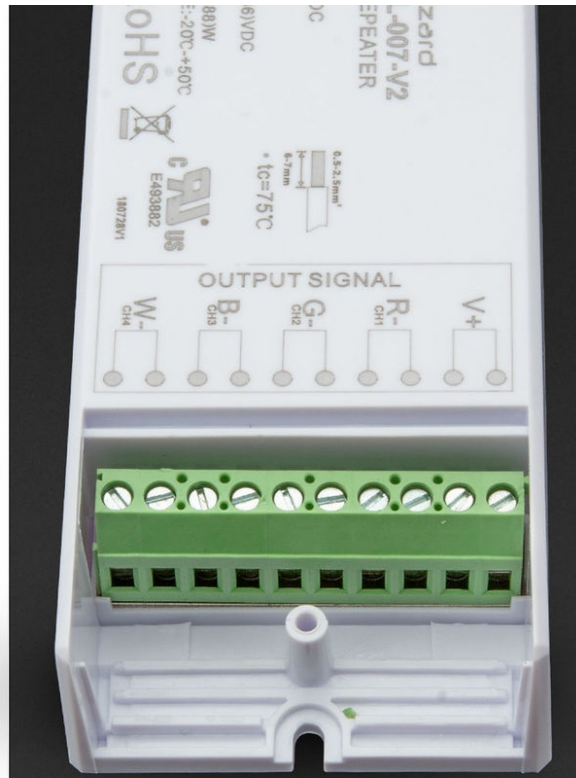

RGB / RGB-W
Fixture

8 Zone RGB-W Waterproof LED Controller Wiring Diagram

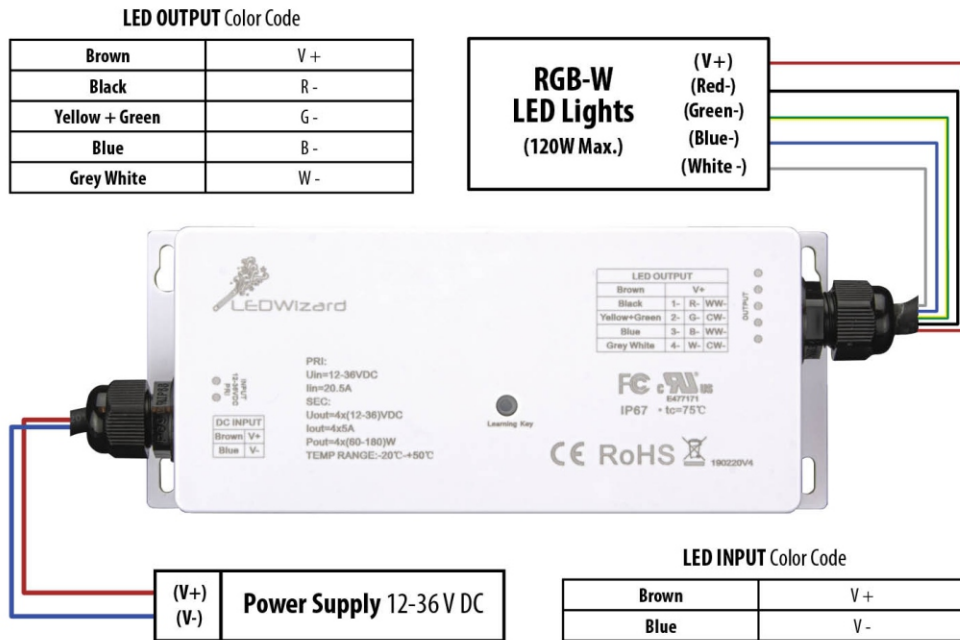

LED Wizard RGB-W 4Ch Signal Amplifier/Repeater Wiring Diagram

